

Wall hung cloakroom system-open install

明装 挂墙衣帽间系统

时尚可以有很多张面孔，精心打造，自由搭配可变空间，不一样的精彩，布局随心所欲，专属你的衣帽间

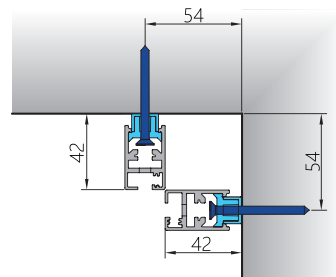

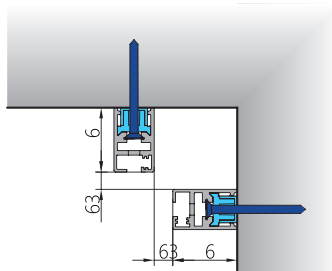
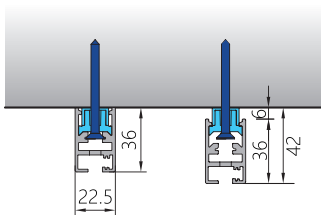
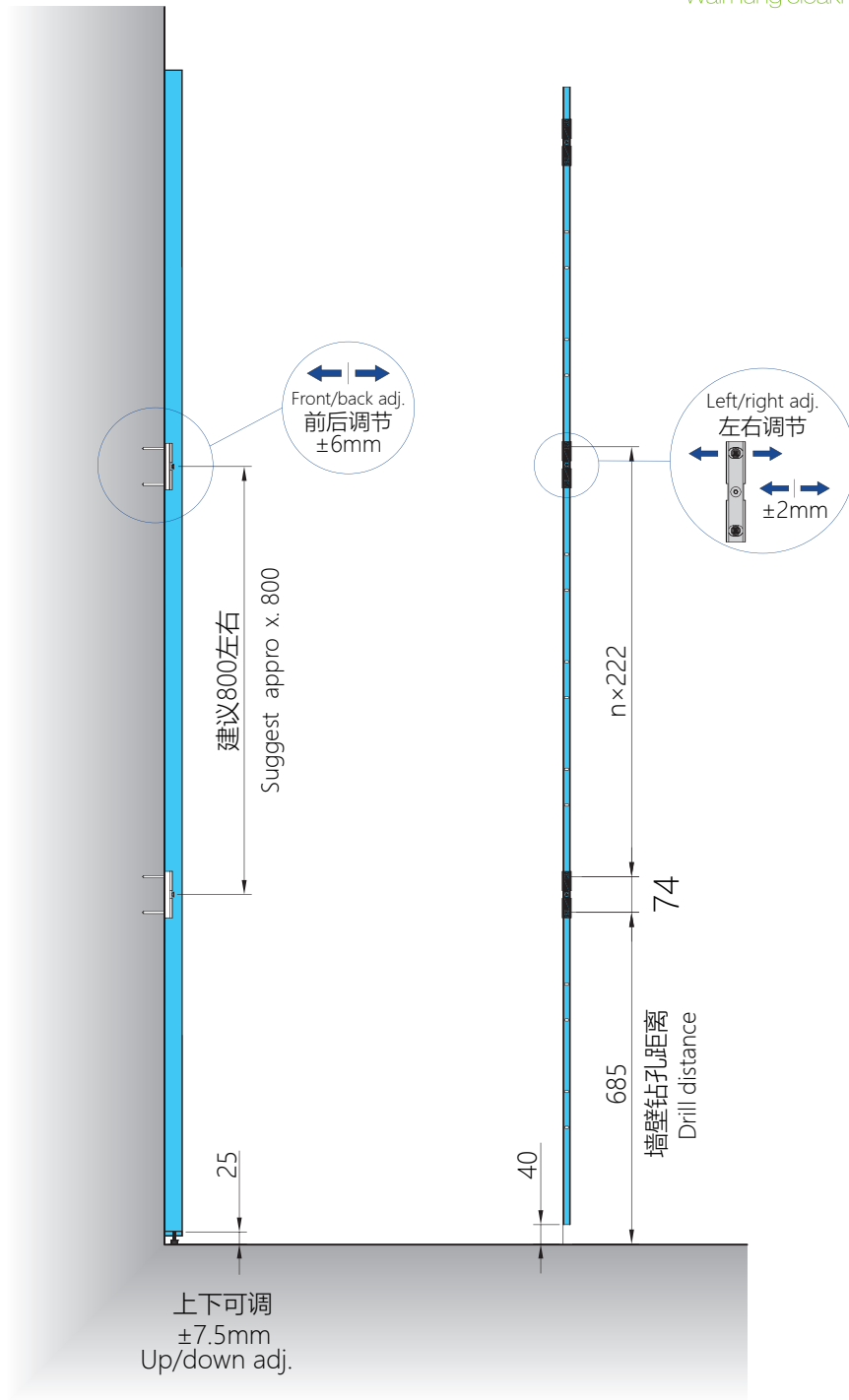

层板共用悬臂安装

安装参考一:

Ref. 1: Laminated shared cantilever installation

注: X 为层板宽度 (单位 mm)

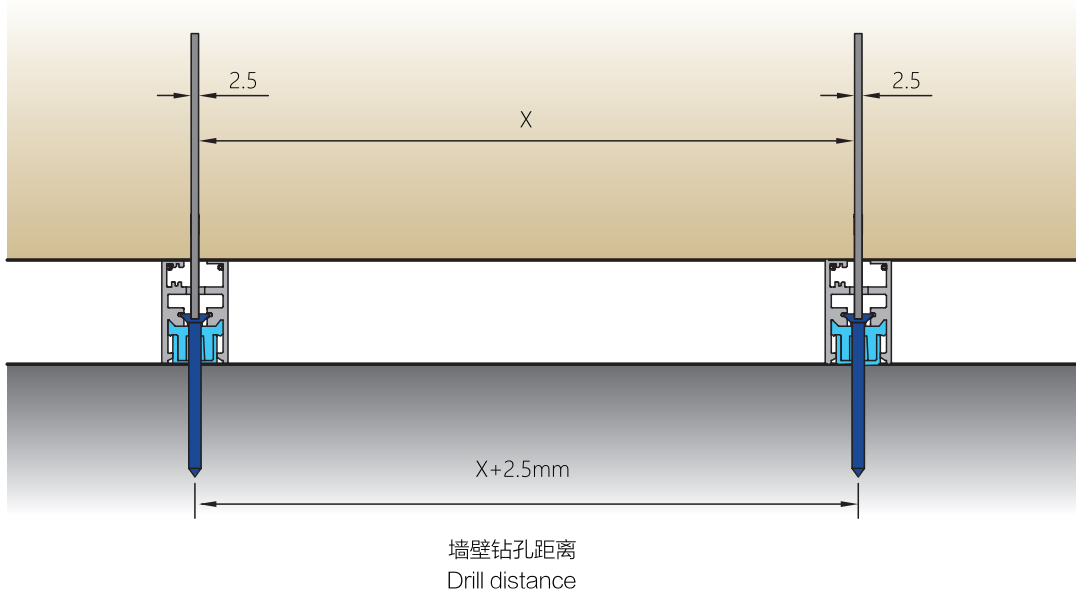

层板独立悬臂安装

安装参考二:

Ref. 2: Laminated separated cantilever installation

注: X 为层板宽度 (单位 mm)

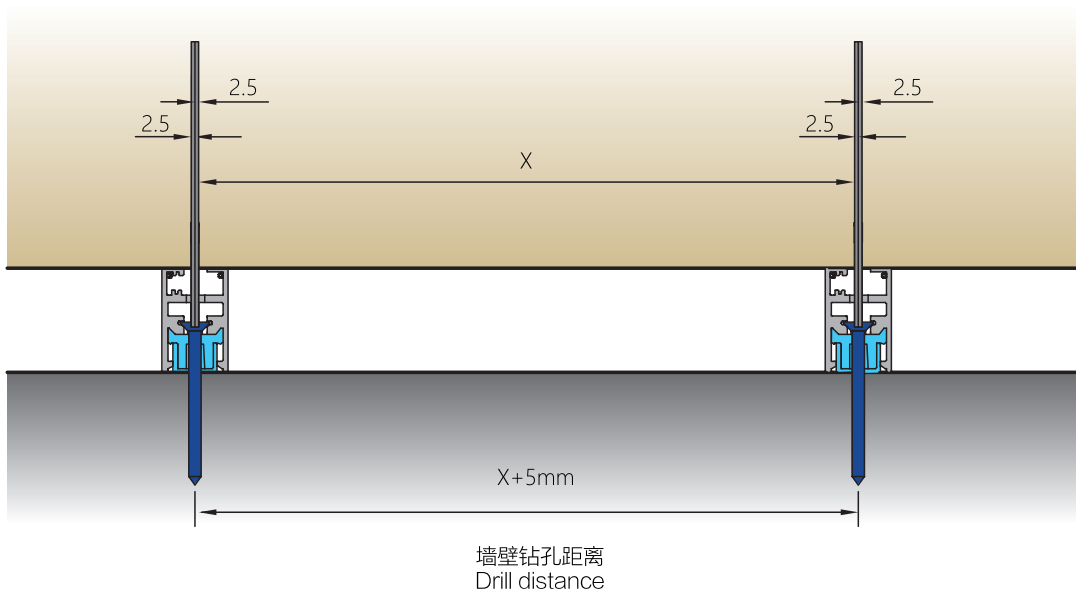

明装挂墙立柱
Wall hung upright column
MR-B-00-00



明装连接立柱
Connected upright column
MR-B-00-01

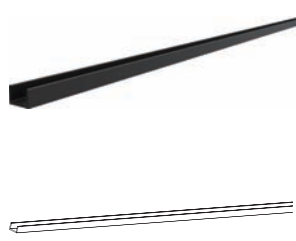

明装调节底座
Adjusting device
MR-B-03-00

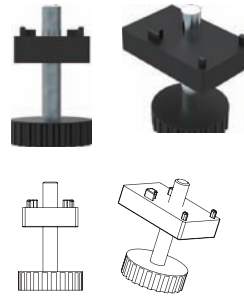

立柱连接码
Column connection
MR-B-03-01

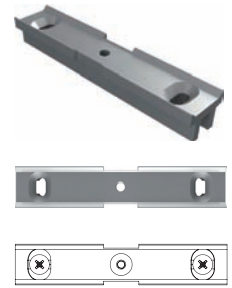

两侧用 -
明装层板悬臂 30mm
Laminated separated cantilever 30mm
MR-B-01-00-30

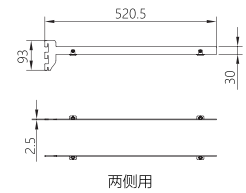

中间用 -
明装层板悬臂 30mm
Laminated shared cantilever 30mm
MR-B-01-01-30

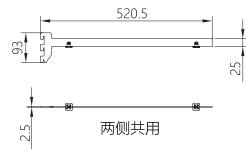

两侧用 -
明装层板悬臂 25mm
Laminated separated cantilever 25mm
MR-B-01-02-25

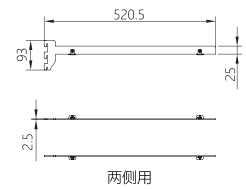
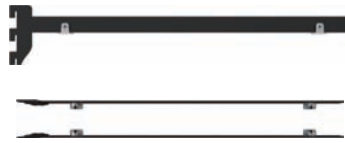

中间用 -
明装层板悬臂 25mm
Laminated shared cantilever 25mm
MR-B-01-03-25

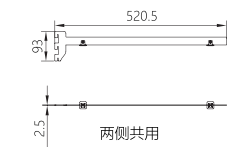

两侧用 -
明装鞋架悬臂 25mm
Shoes rack separated cantilever 25mm
MR-B-01-04-25

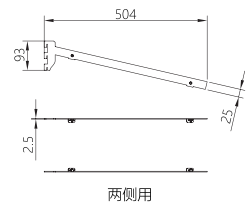
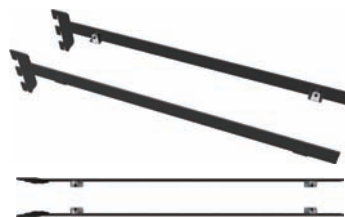

中间用 -
明装鞋架悬臂 25mm
Shoes rack shared cantilever 25mm
MR-B-01-05-25

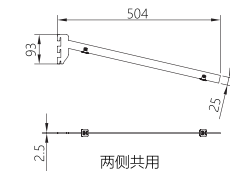

明装吊柜悬臂
Wall cabinet cantilever
MR-B-01-00

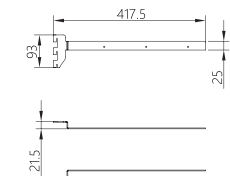

明装 挂墙衣帽间展柜

Wall hung cloakroom system-open install

层板参考尺寸:

层板: 25cm
两侧排 $\Phi 20$ mm 半圆孔及 $\Phi 8$ 深空

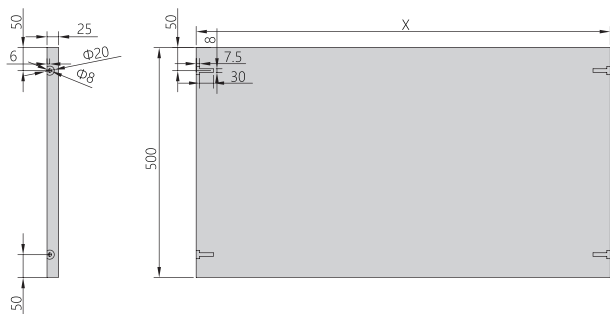

鞋架层板参考尺寸:

层板: 25cm
两侧排 $\Phi 20$ mm 半圆孔及 $\Phi 8$ 深空

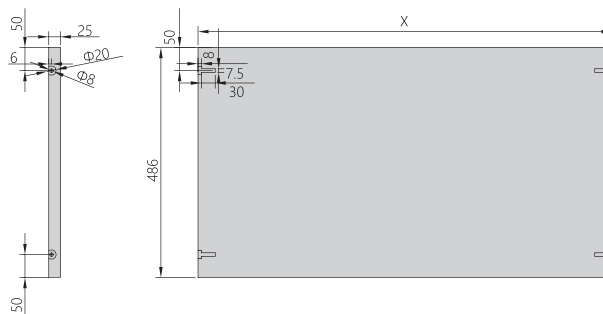

吊柜参考尺寸:

柜体: 顶板 25cm
侧板: 18cm+18cm 厚背板
结构: 顶板盖侧板 三合一+木榫
工艺: 背板两侧开缺口 (图示)

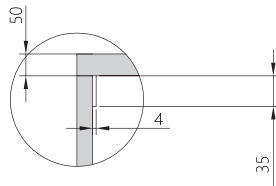
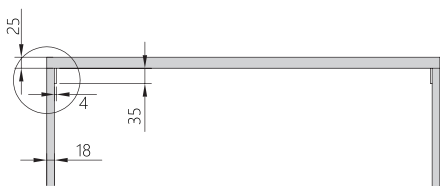

LED 玻璃层板 MR-C-04-00

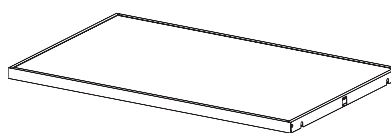
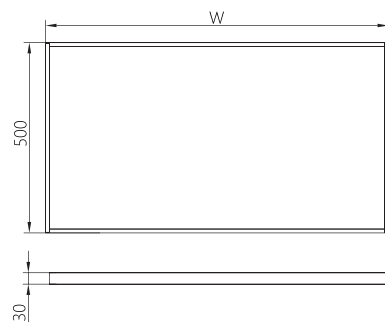
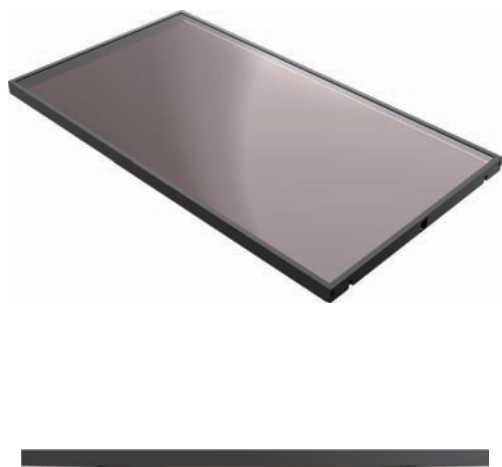

注: 1、常规深度为 500, 宽度 W 为定制;
2、配 4mm 钢化玻璃;
3、带 LED 灯及端子线。